

EASY
TO STORAGE
LIFE SO EASY



2020

SANKAKOGYO

台灣仕様専用機 SIH-BH327BTW

三化工業株式会社

IH COOKING
HEATER

安心!更節能

日本製

讓你輕鬆炒出美味料理



黑色



建議售價 \$ 41000

金色



建議售價 \$ 44000

適用鍋具：

鐵/鑄鐵、琺瑯鐵、不銹鋼(帶磁性)、多層鍋、黏貼鍋



型號名稱	SIH-BH327BTW			
電源	220V(60Hz)	電流 16A	最大功耗(W)	3520W
尺寸(約)	寬720mm x 深420mm x 高70mm			
重量(約)	10kg	適用鍋底直徑	12cm~26cm	
電源線	2.0mm ² 3芯EP橡膠電纜長度70cm			
火力調節	左IH加熱爐	消耗功率	2200W(使用快速加熱器時：2870W)	
		調節範圍	90~2200W 9段調節(快速加熱器除外)	
	右IH加熱爐	消耗功率	2200W	
		調節範圍	90~2200W 9段調節	
烹飪計時器	可設定時間為1分鐘至9小時59分鐘			

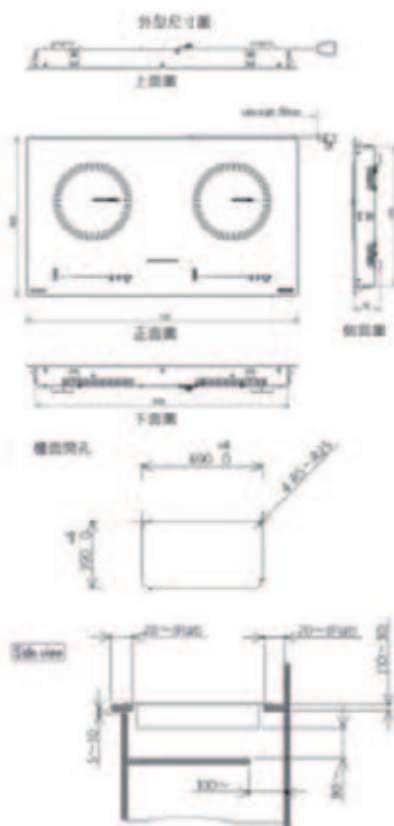

火力顯示	位置	1	2	3	4	5	6	7	8	9	快速加熱器
消耗功率	左右IH爐	相當於 85W	相當於 200W	相當於 360W	相當於 600W	相當於 860W	1170W	1510W	1910W	2200W	2870W
料理方式	保溫	保溫									
	低溫調理	60°C低溫調理								煮水	
							炊具預熱		煎出黃金色澤		
	煮						煮				煮水
	炒			小火拌炒			炊具預熱		大火快炒		爆炒
	炸			蔬菜類油炸			海鮮類、肉品類油炸				
	燉			小火燉煮							
蒸、燜		燜				蒸					煮水

*1.以上僅為參考，各調理方式請根據實際料理狀況進行火力調整

*2.低溫調理需搭配料理用溫度計方可執行

A 衣帽間系列





拉斐阻尼收納架

UNDERWEAR SHELF

型號 Item No.	規格 (寬x深x高) Specification	適用櫃體 Cabinet width	價格 Price
6090360	564x469x85mm	560-568mm	NT\$6800 ●
6090370	664x469x85mm	660-668mm	NT\$7200 ●
6090380	764x469x85mm	760-768mm	NT\$7600 ●
6090390	864x469x85mm	860-868mm	NT\$8000 ●
6110360	564x469x85mm	560-568mm	NT\$6800 ●
6110370	664x469x85mm	660-668mm	NT\$7200 ●
6110380	764x469x85mm	760-768mm	NT\$7600 ●
6110390	864x469x85mm	860-868mm	NT\$8000 ●

● 波爾多紅 BORDEAUX READ ● 太郎灰 HIGHCLASS GREY

■ 材質：鋁合金+皮革



拉斐阻尼西褲架

SOFT-CLOSE TROUSERS RACK

型號 Item No.	規格 (寬x深x高) Specification	適用櫃體 Cabinet width	價格 Price
6090460	564x469x65mm	560-568mm	NT\$5100 ●
6090470	664x469x65mm	660-668mm	NT\$5400 ●
6090480	764x469x65mm	760-768mm	NT\$5700 ●
6090490	864x469x65mm	860-868mm	NT\$6000 ●
6110460	564x469x65mm	560-568mm	NT\$5100 ●
6110470	664x469x65mm	660-668mm	NT\$5400 ●
6110480	764x469x65mm	760-768mm	NT\$5700 ●
6110490	864x469x65mm	860-868mm	NT\$6000 ●

● 波爾多紅 BORDEAUX READ ● 太郎灰 HIGHCLASS GREY

■ 材質：鋁合金+皮革



拉斐阻尼飾物架

SOFT-CLOSE DECORATIONS SHELF

型號 Item No.	規格 (寬x深x高) Specification	適用櫃體 Cabinet width	價格 Price
6090660	564x469x65mm	560-568mm	NT\$5400 ●
6090670	664x469x65mm	660-668mm	NT\$5600 ●
6090680	764x469x65mm	760-768mm	NT\$5800 ●
6090690	864x469x65mm	860-868mm	NT\$6000 ●
6110660	564x469x65mm	560-568mm	NT\$5400 ●
6110670	664x469x65mm	660-668mm	NT\$5600 ●
6110680	764x469x65mm	760-768mm	NT\$5800 ●
6110690	864x469x65mm	860-868mm	NT\$6000 ●

● 波爾多紅 BORDEAUX READ ● 太郎灰 HIGHCLASS GREY

■ 材質：鋁合金+皮革



紫瓏阻尼飾物架

SOFT-CLOSING DECORATIONS SHELF

型號 Item No.	規格 (寬x深x高) Specification	適用櫃體 Cabinet width	價格 Price
6050460	564x480x75mm	564-664mm	NT\$5600
6050470	664x480x75mm	664-764mm	NT\$5700
6050480	764x480x75mm	764-864mm	NT\$5800
6050490	864x480x75mm	864-964mm	NT\$6000

■ 材質：鋁合金



紫瓏阻尼多功能西褲架

SOFT-CLOING MULTIFUNCTIONAL WIAR RACK

型號 Item No.	規格 (寬x深x高) Specification	適用櫃體 Cabinet width	價格 Price
6050580	764x480x160mm	764-864mm	NT\$6300
6050590	864x480x160mm	864-964mm	NT\$6500

■ 材質：鋁合金 ■ 售完為止



紫瓏阻尼飾物架

SOFT-CLOSE DECORATIONS SHELF

型號 Item No.	規格 (寬x深x高) Specification	適用櫃體 Cabinet width	價格 Price
6050660	564x480x80mm	564-664mm	NT\$6800
6050670	664x480x80mm	664-764mm	NT\$7000
6050680	764x480x80mm	764-864mm	NT\$7300
6050690	864x480x80mm	864-964mm	NT\$7600

■ 材質：鋁合金+皮革



IG緩衝可調褲架

ADJUSTABLE TROUSERS RACK

型號 Item No.	規格 (寬x深x高) Specification	適用櫃體 Cabinet width	價格 Price
IG11019W	864x466x75mm	864-924mm	NT\$6100 ○
IG11018W	764x466x75mm	764-824mm	NT\$5800 ○
IG11017W	664x466x75mm	664-724mm	NT\$5500 ○
IG11016W	564x466x75mm	564-624mm	NT\$5100 ○
IG11019C	864x466x75mm	864-924mm	NT\$6100 ●
IG11018C	764x466x75mm	764-824mm	NT\$5800 ●
IG11017C	664x466x75mm	664-724mm	NT\$5500 ●
IG11016C	564x466x75mm	564-624mm	NT\$5100 ●

○ 白色 WHITE ● 咖啡色 BROWN

■ 材質：鋁合金



IG緩衝可調飾品盒

ADJUSTABLE DECORATIONS SHELF

型號 Item No.	規格 (寬x深x高) Specification	適用櫃體 Cabinet width	價格 Price
IG11029W	864x466x85mm	864-924mm	NT\$8400 ○
IG11028W	764x466x85mm	764-824mm	NT\$8100 ○
IG11027W	664x466x85mm	664-724mm	NT\$7700 ○
IG11026W	564x466x85mm	564-624mm	NT\$7250 ○
IG11029C	864x466x85mm	864-924mm	NT\$8400 ●
IG11028C	764x466x85mm	764-824mm	NT\$8100 ●
IG11027C	664x466x85mm	664-724mm	NT\$7700 ●
IG11026C	564x466x85mm	564-624mm	NT\$7250 ●

○ 白色 WHITE ● 咖啡色 BROWN

■ 材質：鋁合金+皮革



IG緩衝可調義式手編藤籃

IG ADJUSTABLE ITALIAN STYLE UNDERWEAR SHELF

型號 Item No.	規格 (寬x深x高) Specification	適用櫃體 Cabinet width	價格 Price
IG16049C	864x460x172mm	864-914mm	NT\$9700
IG16048C	764x460x172mm	764-814mm	NT\$9250
IG16047C	664x460x172mm	664-714mm	NT\$8800
IG16046C	564x460x172mm	564-614mm	NT\$8400

● 咖啡色 BROWN ■ 材質：鋁合金+藤



IG緩衝可調義式活動褲架

IG ADJUSTABLE ITALIAN STYLE TROUSERS RACK

型號 Item No.	規格 (寬x深x高) Specification	適用櫃體 Cabinet width	價格 Price
IG16019C	864x460x67mm	864-914mm	NT\$7500
IG16018C	764x460x67mm	764-814mm	NT\$7000
IG16017C	664x460x67mm	664-714mm	NT\$6700
IG16016C	564x460x67mm	564-614mm	NT\$6400

● 咖啡色 BROWN ■ 材質：鋁合金



IG義式飾品盒

IG ITALIAN STYLE DECORATIONS SHELF

型號 Item No.	規格 (寬x深x高) Specification	適用櫃體 Cabinet width	價格 Price
IG16009C	864x460x76mm	864-914mm	NT\$10400
IG16008C	764x460x76mm	764-814mm	NT\$10000
IG16007C	664x460x76mm	664-714mm	NT\$9700
IG16006C	564x460x76mm	564-614mm	NT\$9250

● 咖啡色 BROWN ■ 材質：鋁合金+皮革



拉斐阻尼頂裝西褲架

SOFT-CLOSE TOP-INSTALL TROUSERS RACK

型號 Item No.	規格 (寬x深x高) Specification	適用櫃體 Cabinet width	價格 Price
6091200	335x460x126mm	-----	NT\$3600 ●
6101200	335x460x126mm	-----	NT\$3600 ○
6111200	335x460x126mm	-----	NT\$3600 ●

● 波爾多紅 BORDEAUX READ ● 太郎灰 HIGHCLASS GREY(訂製款)

○ 香檳金 CHAMPAGEN GOLD

■ 材質：鋁合金



拉斐阻尼頂裝掛衣架

SOFT-CLOSE TOP-INSTALL CLOTHES RACK

型號 Item No.	規格 (寬x深x高) Specification	適用櫃體 Cabinet width	價格 Price
6091301	92x360x126mm	-----	NT\$2300 ●
6091300	92x460x126mm	-----	NT\$2375 ●
6101301	92x360x126mm	-----	NT\$2300 ○
6101300	92x460x126mm	-----	NT\$2375 ○
6111301	92x360x126mm	-----	NT\$2300 ●
6111300	92x460x126mm	-----	NT\$2375 ●

● 波爾多紅 BORDEAUX READ ● 太郎灰 HIGHCLASS GREY(訂製款)

○ 香檳金 CHAMPAGEN GOLD

■ 材質：鋁合金





IG頂裝V型西褲架

IG TOP-INSTALL V-TROUSERS RACK

型號 Item No.	規格 (寬x深x高) Specification	適用櫃體 Cabinet width	價格 Price
IG1402W	340x460x155mm	400mm	NT\$3750 ○
IG1402C	340x460x155mm	400mm	NT\$3750 ●

○ 白色 WHITE ● 咖啡色 BROWN



IG頂裝雙排西褲架

IG TOP-INSTALL DOUBLE ROW-TROUSERS RACK

型號 Item No.	規格 (寬x深x高) Specification	適用櫃體 Cabinet width	價格 Price
IG1401W	630x460x130mm	700mm	NT\$4350 ○
IG1401C	630x460x130mm	700mm	NT\$4350 ●

○ 白色 WHITE ● 咖啡色 BROWN



IG頂裝八珠掛衣架

IG TOP-INSTALL CLOTHES RACK (8BEAD)

型號 Item No.	規格 (寬x深x高) Specification	適用櫃體 Cabinet width	價格 Price
IG1403W	86x458x140mm	400mm	NT\$2450 ○
IG1403C	86x458x140mm	400mm	NT\$2450 ●

○ 白色 WHITE ● 咖啡色 BROWN



IG頂裝五珠掛衣架

IG TOP-INSTALL CLOTHES RACK (5BEAD)

型號 Item No.	規格 (寬x深x高) Specification	適用櫃體 Cabinet width	價格 Price
IG1403-1W	86x307x140mm	400mm	NT\$2300 ○
IG1403-1C	86x307x140mm	400mm	NT\$2300 ●

○ 白色 WHITE ● 咖啡色 BROWN



IG緩衝側拉二層領帶架

IG BUFFER DOUBLE LAYER TIE RACK

型號 Item No.	規格 (寬x深x高) Specification	適用櫃體 Cabinet width	價格 Price
IG 1304W	120x465x220mm	364mm	NT\$3625 ○
IG 1304C	120x465x220mm	364mm	NT\$3625 ●

○ 白色 WHITE ● 咖啡色 BROWN

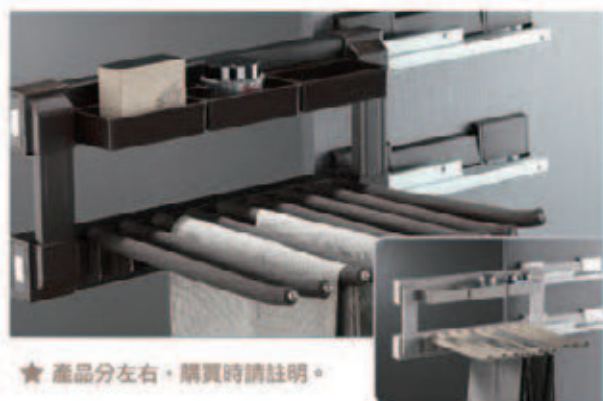

IG緩衝側拉二層活動褲架

IG BUFFER DOUBLE LAYER TROUSERS RACK

型號 Item No.	規格 (寬x深x高) Specification	適用櫃體 Cabinet width	價格 Price
IG 1314W	370x465x220mm	414mm	NT\$4350 ○
IG 1314C	370x465x220mm	414mm	NT\$4350 ●

○ 白色 WHITE ● 咖啡色 BROWN

★ 產品分左右，購買時請註明。



IG側拉組合式領帶架

IG BUFFER COMBINATION TIE RACK

型號 Item No.	規格 (寬x深x高) Specification	適用櫃體 Cabinet width	價格 Price
IG 1305W	164x460x100mm	200mm	NT\$2175 ○
IG 1305C	164x460x100mm	200mm	NT\$2175 ●

○ 白色 WHITE ● 咖啡色 BROWN

★ 產品分左右，購買時請註明。

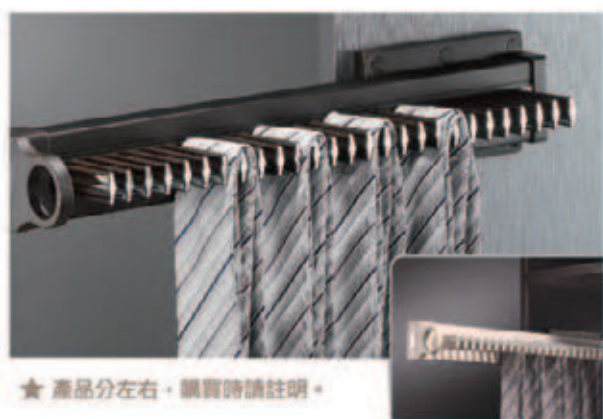

IG側拉領帶架

IG BUFFER TIE RACK

型號 Item No.	規格 (寬x深x高) Specification	適用櫃體 Cabinet width	價格 Price
IG 1315W	164x460x100mm	200mm	NT\$2325 ○
IG 1315C	164x460x100mm	200mm	NT\$2325 ●

○ 白色 WHITE ● 咖啡色 BROWN

★ 產品分左右，購買時請註明。



拉斐阻尼升降掛衣架

RALPHIE SOFT-CLOSE LIFTABLE HANGER

型號 Item No.	規格 (寬x深x高) Specification	適用櫃體 Cabinet width	價格 Price
6091601	(564-764)x150x900mm	564-764mm	NT\$4300 ●
6091602	(764-1064)x150x900mm	764-1064mm	NT\$4500 ●
6101601	(564-764)x150x900mm	564-764mm	NT\$4300 ●
6101602	(764-1064)x150x900mm	764-1064mm	NT\$4500 ●
6111601	(564-764)x150x900mm	564-764mm	NT\$4300 ●
6111602	(764-1064)x150x900mm	764-1064mm	NT\$4500 ●

● 波蘭多紅 BORDEAUX RED ● 太郎灰 HIGHCLASS GREY(訂製款)

● 香檳金 CHAMPAGEN GOLD

■ 材質：鋁合金



IG雙緩衝升降衣架

IG TOP-INSTALL V-TROUSERS RACK

型號 Item No.	規格 (寬x深x高) Specification	適用櫃體 Cabinet width	價格 Price
IG02AS	(734-1114)x333x945mm	734-1114mm	NT\$7950
IG02BS	(584-794)x333x945mm	584-794mm	NT\$7950
IG02AC	(734-1114)x333x945mm	734-1114mm	NT\$7950
IG02BC	(584-794)x333x945mm	584-794mm	NT\$7950

○ 白色 WHITE ● 咖啡色 BROWN

■ 材質：鋁合金





拉斐頂裝旋轉掛衣架

TOP-INSTALL ROTATABLE HANGER

型號 Item No.	規格 (寬x深x高) Specification	適用櫃體 Cabinet width	價格 Price
6091700	Φ520xH125mm	764mm以上	NT\$3180 ●
6101700	Φ520xH125mm	764mm以上	NT\$3180 ●
6111700	Φ520xH125mm	764mm以上	NT\$3180 ●

● 波爾多紅 BORDEAUX READ ● 太郎灰 HIGHCLASS GREY(訂製款)

● 香檳金 CHAMPAGEN GOLD

■ 材質：鋁合金

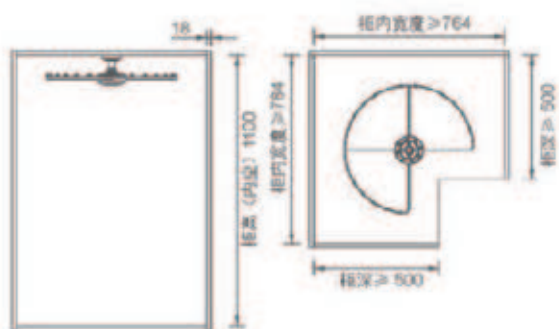



IG頂裝旋轉掛衣架

IG TOP-INSTALL ROTATABLE HANGER

型號 Item No.	規格 (寬x深x高) Specification	適用櫃體 Cabinet width	價格 Price
IG601A	Φ540xH160mm	764-864mm	NT\$3180
IG601A-1	Φ420xH160mm	664-764mm	NT\$3180
IG601AC	Φ540xH160mm	764-864mm	NT\$3180
IG601AC-1	Φ420xH160mm	664-764mm	NT\$3180

○ 白色 WHITE

● 咖啡色 BROWN



IG頂裝旋轉褲架

IG TOP-INSTALL TROUSERS RACK

型號 Item No.	規格 (寬x深x高) Specification	適用櫃體 Cabinet width	價格 Price
IG601B	Φ730xH160mm	764-964mm	NT\$3180
IG601BC	Φ730xH160mm	764-964mm	NT\$3180

○ 白色 WHITE

● 咖啡色 BROWN



拉斐360度三層轉盤

360° THREE-TIER ROTATABLE CORNER SHELF

型號 Item No.	規格 (寬x深x高) Specification	適用櫃體 Cabinet width	價格 Price
6092000	Φ710xH935mm	764mm以上	NT\$13400 ●
6102000	Φ710xH935mm	764mm以上	NT\$13400 ●
6112000	Φ710xH935mm	764mm以上	NT\$13400 ●

- 波爾多紅 BORDEAUX READ
- 太郎灰 HIGHCLASS GREY(訂製款)
- 香檳金 CHAMPAGEN GOLD
- 材質：鋁合金

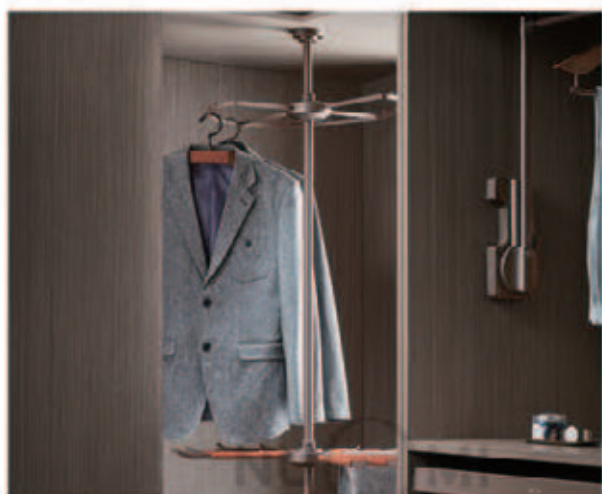
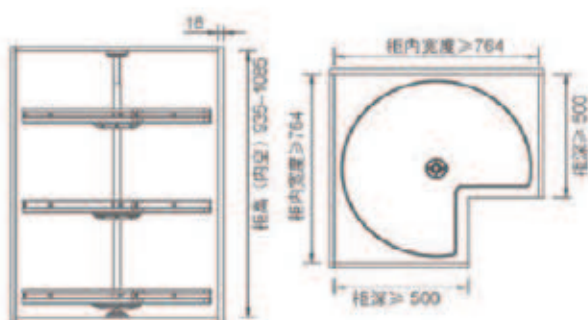

拉斐高櫃旋轉多功能組合架

HIGH ROTATABLE MULTIFUNCTIONAL SHELF

型號 Item No.	規格 (寬x深x高) Specification	適用櫃體 Cabinet width	價格 Price
6092100	Φ710xH(1910-2110)mm	764mm以上	NT\$11000 ●
6102100	Φ710xH(1910-2110)mm	764mm以上	NT\$11000 ●
6112100	Φ710xH(1910-2110)mm	764mm以上	NT\$11000 ●

- 波爾多紅 BORDEAUX READ
- 太郎灰 HIGHCLASS GREY(訂製款)
- 香檳金 CHAMPAGEN GOLD
- 材質：鋁合金

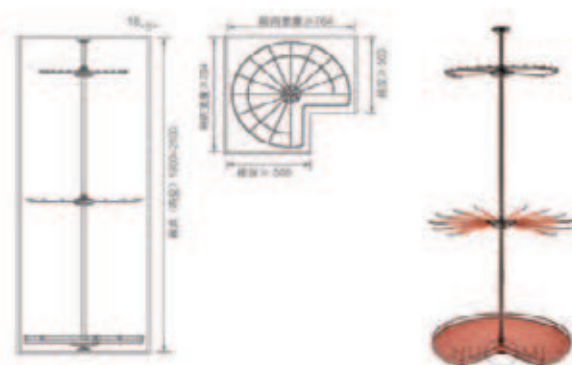



IG三層轉角衣物籃

IG THIRD-TIER ROTATABLE CORNER SHELF

型號 Item No.	規格 (寬x深x高) Specification	適用櫃體 Cabinet width	價格 Price
IG602AW	Φ730xH1900-2100mm	764-864mm	NT\$11000 ○
IG602AC	Φ730xH1900-2100mm	764-864mm	NT\$11000 ●

○ 白色 WHITE

● 咖啡色 BROWN



IG二層轉角衣物籃

IG TWO-TIER ROTATABLE CORNER SHELF

型號 Item No.	規格 (寬x深x高) Specification	適用櫃體 Cabinet width	價格 Price
IG602BW	Φ730xH880-1000mm	764-864mm	NT\$8250 ○
IG602BC	Φ730xH880-1000mm	764-864mm	NT\$8250 ●

○ 白色 WHITE

● 咖啡色 BROWN



IG三層旋轉衣物籃

IG THREE-TIER ROTATABLE CORNER SHELF

型號 Item No.	規格 (寬x深x高) Specification	適用櫃體 Cabinet width	價格 Price
IG604BW	Φ710xH800-935mm	764-864mm	NT\$14500 ○
IG604BC	Φ710xH800-935mm	764-864mm	NT\$14500 ●

○ 白色 WHITE ● 咖啡色 BROWN



IG四層轉角衣物籃

IG ING FOURTH-TIER ROTATABLE CORNER SHELF

型號 Item No.	規格 (寬x深x高) Specification	適用櫃體 Cabinet width	價格 Price
IG603W	Φ710xH1900-2100mm	764-864mm	NT\$16775 ○
IG603C	Φ710xH1900-2100mm	764-864mm	NT\$16775 ●

○ 白色 WHITE ● 咖啡色 BROWN



IG六層旋轉衣物籃

IG SIXTH-TIER ROTATABLE CORNER SHELF

型號 Item No.	規格 (寬x深x高) Specification	適用櫃體 Cabinet width	價格 Price
IG604AW	Φ710xH1585-1720mm	764-864mm	NT\$28950 ○
IG604AC	Φ710xH1585-1720mm	764-864mm	NT\$28950 ●

○ 白色 WHITE ● 咖啡色 BROWN



IG緩衝側拉三層手編飾籃

IG BUFFER THIRD FLOOR JEWELRY BASKET

型號 Item No.	規格 (寬x深x高) Specification	適用櫃體 Cabinet width	價格 Price
IG1300W	360x465x765mm	364mm	NT\$8975 ○
IG1300C	360x465x765mm	364mm	NT\$8975 ●

○ 白色 WHITE ● 咖啡色 BROWN

★ 產品分左右，購買時請註明。

IG緩衝可調手編藤籃

IG ADJUSTABLE RATTAN BASKET



型號 Item No.	規格 (寬x深x高) Specification	適用櫃體 Cabinet width	價格 Price
IG11039W	864x466x200mm	864-924mm	NT\$8525 ○
IG11038W	764x466x200mm	764-824mm	NT\$7950 ○
IG11037W	664x466x200mm	664-724mm	NT\$7500 ○
IG11036W	564x466x200mm	564-624mm	NT\$7250 ○
IG11039C	864x466x200mm	864-924mm	NT\$8525 ●
IG11038C	764x466x200mm	764-824mm	NT\$7950 ●
IG11037C	664x466x200mm	664-724mm	NT\$7500 ●
IG11036C	564x466x200mm	564-624mm	NT\$7250 ●

○ 白色 WHITE ● 咖啡色 BROWN



IG 緩衝可調衣物籃

IG ADJUSTABLE CLOTHES BASKET

型號 Item No.	規格(寬x深x高) Specification	適用櫃體 Cabinet width	價格 Price
IG11059W	864x466x158mm	864-924mm	NT\$7250
IG11058W	764x466x158mm	764-824mm	NT\$6800
IG11057W	664x466x158mm	664-724mm	NT\$6375
IG11056W	564x466x158mm	564-624mm	NT\$6075
IG11059C	864x466x158mm	864-924mm	NT\$7250
IG11058C	764x466x158mm	764-824mm	NT\$6800
IG11057C	664x466x158mm	664-724mm	NT\$6375
IG11056C	564x466x158mm	564-624mm	NT\$6075

○ 白色 WHITE

● 咖啡色 BROWN



拉斐旋轉鞋架

360° ROTATABLE MULTI-LAYER SHOES RACK

型號 Item No.	規格(寬x深x高) Specification	適用櫃體 Cabinet width	層數 Layer	價格 Price
6092303	700x360x (1350-1550)mm	764mm以上	8層	NT\$20000
6092304	700x360x (1910-2110)mm	764mm以上	12層	NT\$22000
6102303	700x360x (1350-1550)mm	764mm以上	8層	NT\$20000
6102304	700x360x (1910-2110)mm	764mm以上	12層	NT\$22000
6112303	700x360x (1350-1550)mm	764mm以上	8層	NT\$20000
6112304	700x360x (1910-2110)mm	764mm以上	12層	NT\$22000

● 波爾多紅 BORDEAUX READ

● 太郎灰 HIGHCLASS GREY(訂製款)

● 香檳金 CHAMPAGEN GOLD

■ 材質：鋁合金+皮革



IG旋轉鞋架

IG 360°ROTATABLE MULTI-LAYER SHOES RACK

型號 Item No.	規格(寬x深x高) Specification	適用櫃體 Cabinet width	層數 Layer	價格 Price
IG50312	700x356x (1910-2110)mm	764mm	12層	NT\$28950
IG50309	700x356x (1510-1710)mm	764mm	9層	NT\$27500
IG50308	700x356x (360-1560)mm	764mm	8層	NT\$26050



翼瓏360°度旋轉多層鞋架

360°ROTATABLE MULTI-LAYER SHOES RACK

型號 Item No.	規格(寬x深x高) Specification	適櫃 Cabinet width	層數 Layer	價格 Price
6062304A	700x360x (1910-2110)mm	764mm以上	12層	NT\$19500

■ 材質：鋁合金 ■ 售完為止





拉斐推拉旋轉鏡R角/直角

RALPHIE ROTATING MIRROR R / RIGHT ANGLE

型號 Item No.	規格(寬x深x高) Specification	適用櫃體 Cabinet width	弧度 Radian	價格 Price
6092500	42x350x1000mm	280mm以上	R角	NT\$5600 ●
6092501	42x350x1000mm	280mm以上	直角	NT\$5200 ●
6102500	42x350x1000mm	280mm以上	R角	NT\$5500 ●
6102501	42x350x1000mm	280mm以上	直角	NT\$5200 ●
6112500	42x350x1000mm	280mm以上	R角	NT\$5800 ●
6112501	42x350x1000mm	280mm以上	直角	NT\$5200 ●

● 波爾多紅 BORDEAUX READ ● 太郎灰 HIGHCLASS GREY(訂製款)

● 香檳金 CHAMPAGEN GOLD

■ 材質：鋁合金



紫瓏簡約型推拉旋轉鏡

VIOLET SIMPLE SLIDING MIRROR

型號 Item No.	規格(寬x深x高) Specification	適用櫃體 Cabinet width	價格 Price
6052500	48x396x1216mm	NT\$5500

■ 材質：鋁合金



拉斐多功能收納盒(小)

RALPHIE MULTI-FUNCTIONAL STORAGE BOX ■ 材質：皮革

型號 Item No.	規格(寬x深x高) Specification	適用櫃體 Cabinet width	價格 Price
6093600	150x410x55mm	-----	NT\$1750

■ 不含櫃體



拉斐多功能收納盒(大)

RALPHIE MULTI-FUNCTIONAL STORAGE BOX ■ 材質：皮革

型號 Item No.	規格(寬x深x高) Specification	適用櫃體 Cabinet width	價格 Price
6094200	260x410x55mm	-----	NT\$2325

■ 不含櫃體



拉斐多功能手錶盒

RALPHIE MULTI-FUNCTION WATCH BOX ■ 材質：皮革

型號 Item No.	規格(寬x深x高) Specification	適用櫃體 Cabinet width	價格 Price
6093800	150x410x55mm	-----	NT\$2800

■ 不含櫃體



拉斐多功能戒指盒

RALPHIE MULTI-FUNCTION RING BOX ■ 材質：皮革

型號 Item No.	規格(寬x深x高) Specification	適用櫃體 Cabinet width	價格 Price
6093700	150x410x55mm	-----	NT\$2400

■ 不含櫃體

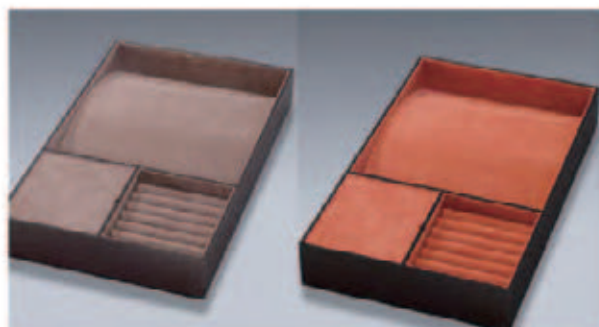

IG多功能收納盒

IG MULTIFUNCTION STORAGE BOX

■ 材質：皮革

型號 Item No.	規格(寬x深x高) Specification	適用櫃體 Cabinet width	價格 Price
IG19081T	250x414x55mm	-----	NT\$2600
IG19081C	250x414x55mm	-----	NT\$2600

● 咖啡色 BROWN ● 橘黑色 ORANGE、BLACK ■ 不含櫃體



IG手錶盒

IG MULTI-FUNCTION WATCH BOX

■ 材質：皮革

型號 Item No.	規格(寬x深x高) Specification	適用櫃體 Cabinet width	價格 Price
IG19082T	250x414x55mm	-----	NT\$2900
IG19082C	250x414x55mm	-----	NT\$2900

● 咖啡色 BROWN ● 橘黑色 ORANGE、BLACK ■ 不含櫃體

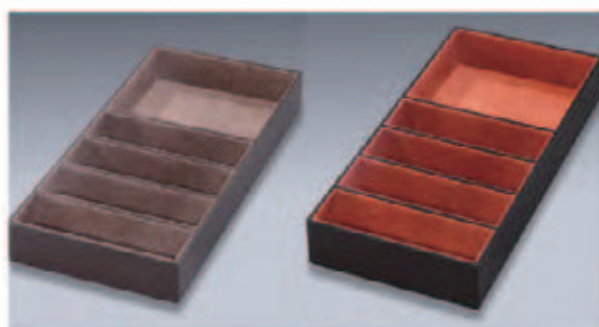

IG飾品收納盒

IG MULTI-FUNCTION ACCESSORIES BOX

■ 材質：皮革

型號 Item No.	規格(寬x深x高) Specification	適用櫃體 Cabinet width	價格 Price
IG19083T	200x414x55mm	-----	NT\$2325
IG19083C	200x414x55mm	-----	NT\$2325

● 咖啡色 BROWN ● 橘黑色 ORANGE、BLACK ■ 不含櫃體

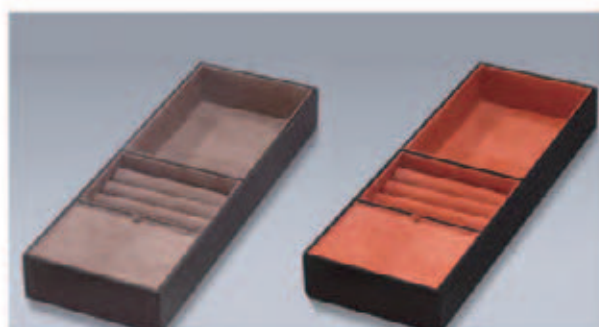

IG多功能收納盒(小)

IG MULTI-FUNCTIONAL STORAGE BOX(S)

■ 材質：皮革

型號 Item No.	規格(寬x深x高) Specification	適用櫃體 Cabinet width	價格 Price
IG19084T	150x414x55mm	-----	NT\$2325
IG19084C	150x414x55mm	-----	NT\$2325

● 咖啡色 BROWN ● 橘黑色 ORANGE、BLACK ■ 不含櫃體

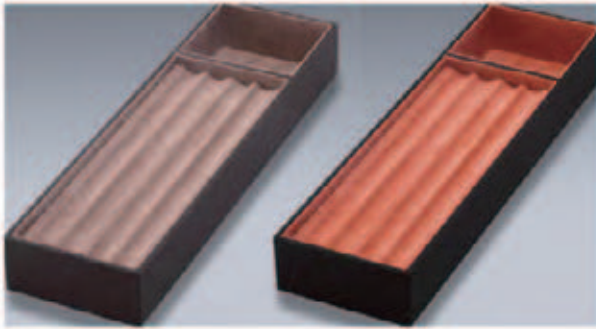

IG 多功能收納盒

IG MULTI-FUNCTIONAL STORAGE BOX

■ 材質：皮革

型號 Item No.	規格(寬x深x高) Specification	適用櫃體 Cabinet width	價格 Price
IG19085T	120x414x55mm	-----	NT\$2025
IG19085C	120x414x55mm	-----	NT\$2025

● 咖啡色 BROWN

● 橘黑色 ORANGE · BLACK

■ 不含櫃體

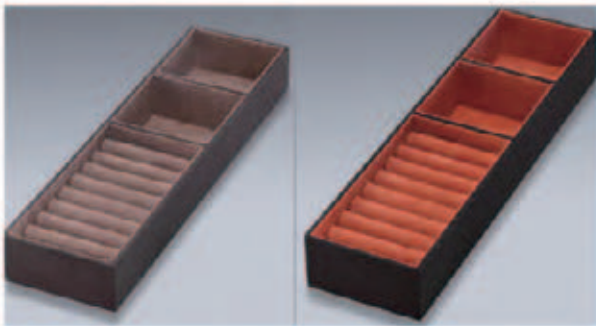

IG 長型飾品盒

IG LONG TYPE ACCESSORIES BOX

■ 材質：皮革

型號 Item No.	規格(寬x深x高) Specification	適用櫃體 Cabinet width	價格 Price
IG19086T	115x414x55mm	-----	NT\$2025
IG19086C	115x414x55mm	-----	NT\$2025

● 咖啡色 BROWN

● 橘黑色 ORANGE · BLACK

■ 不含櫃體

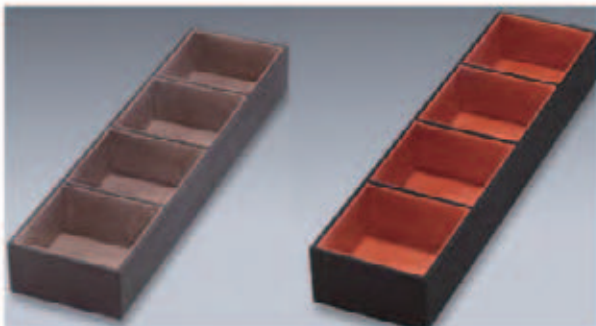

IG 飾品收納盒

IG ACCESSORIES BOX

■ 材質：皮革

型號 Item No.	規格(寬x深x高) Specification	適用櫃體 Cabinet width	價格 Price
IG19087T	110x414x55mm	-----	NT\$1750
IG19087C	110x414x55mm	-----	NT\$1750

● 咖啡色 BROWN

● 橘黑色 ORANGE · BLACK

■ 不含櫃體

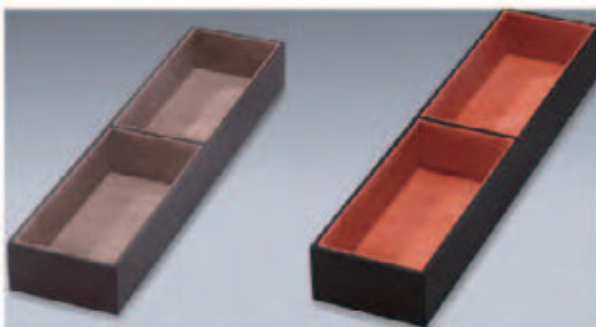

IG 多功能收納盒

IG MULTI-FUNCTION ACCESSORIES BOX

■ 材質：皮革

型號 Item No.	規格(寬x深x高) Specification	適用櫃體 Cabinet width	價格 Price
IG19088T	100x414x55mm	-----	NT\$1750
IG19088C	100x414x55mm	-----	NT\$1750

● 咖啡色 BROWN

● 橘黑色 ORANGE · BLACK

■ 不含櫃體



德式加高型衣櫥拉籃(附一般滑軌)
GERMAN STYLE HEIGHTENED WARDROBE BLUE

型號 Item No.	規格 (寬x深x高) Specification	適用櫃體 Cabinet width	價格 Price
K02045	410~418x470x210mm	450mm	NT\$1500
K02050	460~468x470x210mm	500mm	NT\$1600
K02060	560~568x470x210mm	600mm	NT\$1600
K02070	660~668x470x210mm	700mm	NT\$1700
K02080	760~768x470x210mm	800mm	NT\$1700
K02090	860~868x470x210mm	900mm	NT\$1800
K020100	960~968x470x210mm	1000mm	NT\$1900

■ 滑軌種類及價格

滑軌名稱	深度	高度	價格
附鋼珠緩衝滑軌(-3)			+500
附座式滑軌(開放式)(-5)	多15mm	多35mm	+1200
附座式滑軌(壓頭式)(-6)	多15mm	多35mm	+1460



■ 附鋼珠緩衝滑軌(-3)

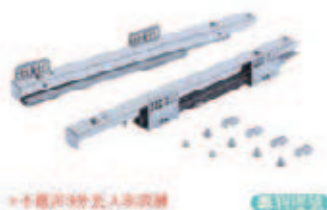

■ 附座式滑軌(開放式)(-5)



■ 附座式滑軌(壓頭式)(-6)

吊衣桿(鐵灰)(鋁)

SLING ROD

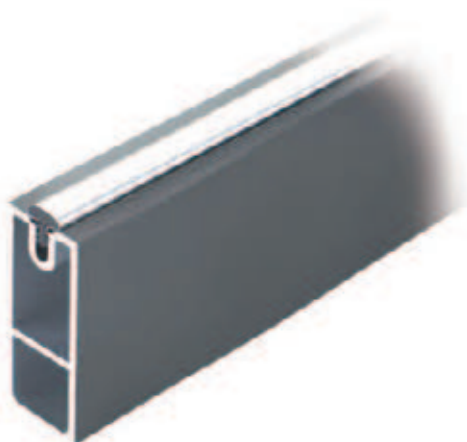

型號 Item No.	尺寸 size	價格 Price
GY009	3米	NT\$1000
GY009-100	956mm	NT\$325
GY009-90	856mm	NT\$310
GY009-80	756mm	NT\$300
GY009-60	556mm	NT\$290
GY009-45	406mm	NT\$270
GY009-40	356mm	NT\$260

★ 不含日玉

吊衣桿(鋁)

SLING ROD

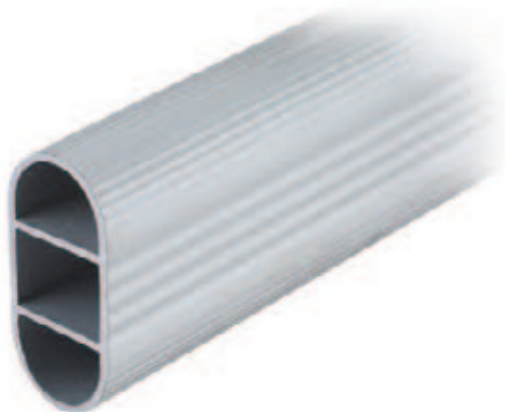

型號 Item No.	尺寸 size	價格 Price
GY007	3米	NT\$800
GY007B	3米	NT\$850

● 銀色 ● 黑色 ★ 不含日玉

吊衣桿(鐵鍍鉻)

SLING ROD



型號 Item No.	尺寸 size	適櫃 Cabinet width	價格 Price
K05040	356x15x30mm	400mm	NT\$120
K05045	406x15x30mm	450mm	NT\$140
K05050	456x15x30mm	500mm	NT\$150
K05060	556x15x30mm	600mm	NT\$150
K05080	756x15x30mm	800mm	NT\$180
K05090	856x15x30mm	900mm	NT\$200
K050100	956x15x30mm	1000mm	NT\$220
K05120	1156x15x30mm	1200mm	NT\$240
K05150	1456x15x30mm	1500mm	NT\$330
K050300	3000x15x30mm	不含日玉	NT\$800



目玉(方管座)

型號 Item No.	規格 Specification	顏色 color	價格 Price
D009K	2個一組	鐵灰	NT\$130



目玉(橢圓管座) (其他顏色價格另報)

型號 Item No.	規格 Specification	顏色 color	價格 Price
80001	15x30用	鎊	15



上裝中空目玉(方管座)

型號 Item No.	規格 Specification	顏色 color	價格 Price
D009Q	1個	鐵灰	NT\$100

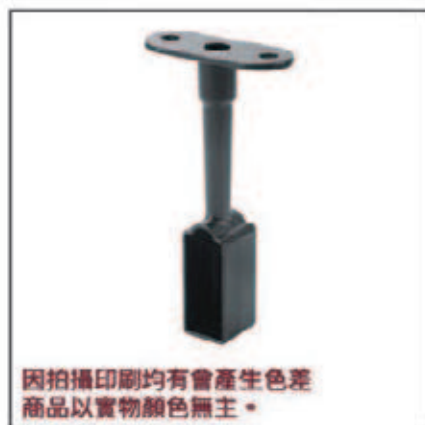

上裝目玉(方管座)

型號 Item No.	規格 Specification	顏色 color	價格 Price
D009B	1個	鐵灰	NT\$200

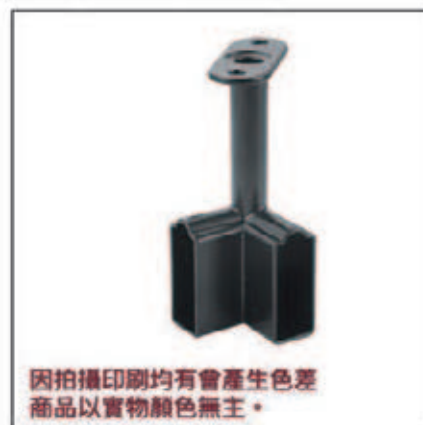

上裝轉角目玉(方管座)

型號 Item No.	規格 Specification	顏色 color	價格 Price
D009Z	1個	鐵灰	NT\$250



上裝中空目玉(橢圓管座)

型號 Item No.	規格 Specification	顏色 color	價格 Price
A-018	1個	黑 / 銀	NT\$120



上裝目玉(橢圓管座)

型號 Item No.	規格 Specification	顏色 color	價格 Price
H-01	1個	黑 / 銀	NT\$120



門板反彈器
NT\$300

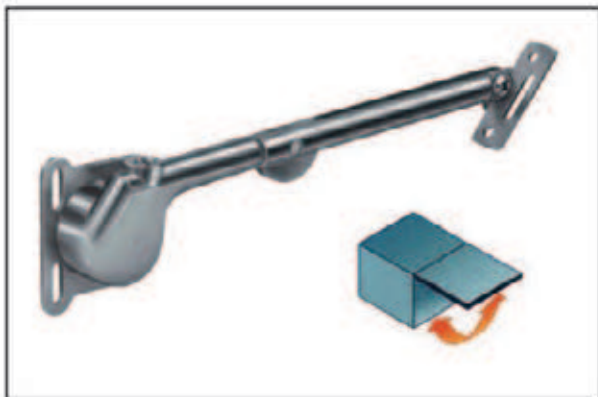

600型上掀桿
LIFT THE BAR UP

型號	適用	價格
04CEA600左	高度190mm以上	NT\$825
04CEA600右	高度190mm以上	NT\$825

■ 木門用 ■ 鋁鎂框用(需加價)

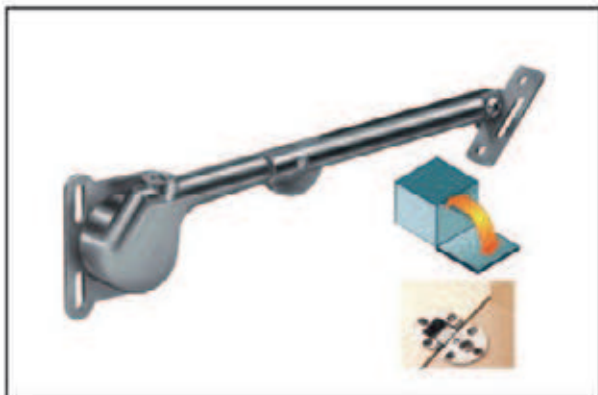

601型下掀桿
LIFT THE BAR UP

型號	適用	價格
04CEA601左	高度205mm以上	NT\$825
04CEA601右	高度205mm以上	NT\$825

■ 木門用 ■ 鋁鎂框用(需加價)

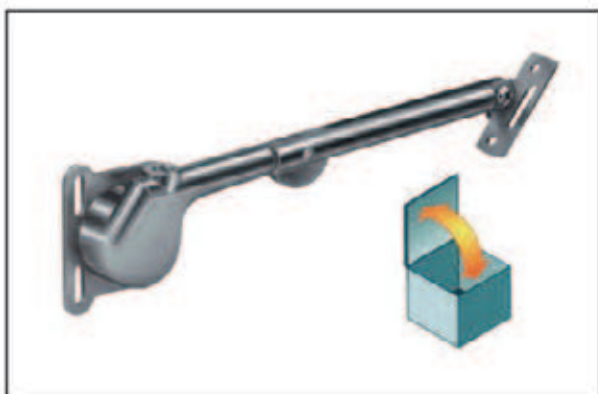

602型平掀桿
LIFT THE BAR UP

型號	適用	價格
04CEA602左	高度110mm以上	NT\$825
04CEA602右	高度110mm以上	NT\$825

■ 木門用 ■ 鋁鎂框用(需加價)



可調式重型緩衝降撐桿-平掀

型號	最小內徑	最小深度	價格
D03040	130mm以上	210mm以上	NT\$1250

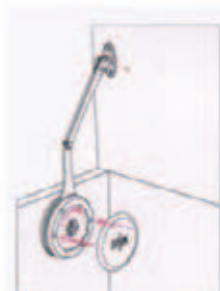

可調式重型緩降撐桿-下掀

型號	最小內徑	最小深度	價格
D03041	150mm以上	200mm以上	NT\$1250

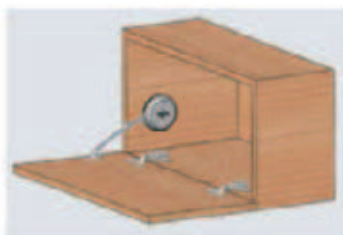

可調式定點、緩降-上掀撐桿

型號	最小內徑	最小深度	價格
D03043 (標準型)	265mm以上	55mm以上	NT\$950
D03043-1 (重型)	265mm以上	55mm以上	NT\$1350





Panasonic旋轉衣架(小座)

Panasonic ROTATING HANGER

型號 Item No.	規格 (寬x深x高) Specification	收納量 Storage capacity
HC030101	1680x800x2350mm	薄衣約70件 / 厚衣約50件

■ 承重15kg

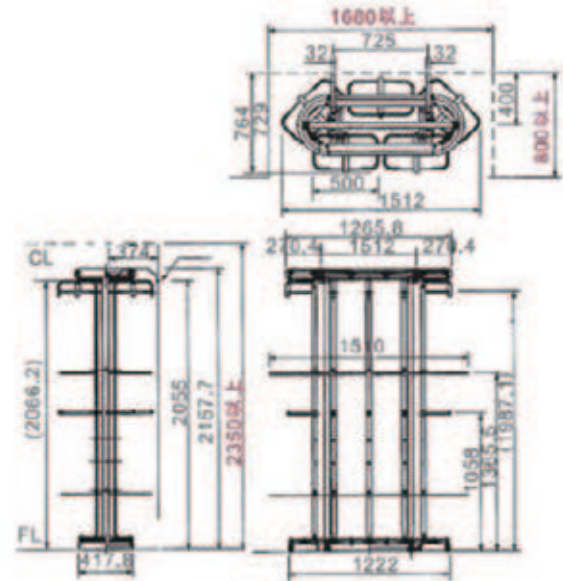

Panasonic旋轉衣架(大座)

Panasonic ROTATING HANGER

型號 Item No.	規格 (寬x深x高) Specification	收納量 Storage capacity
HC030102	2520x800x2350mm	薄衣約112件 / 厚衣約80件

■ 承重15kg

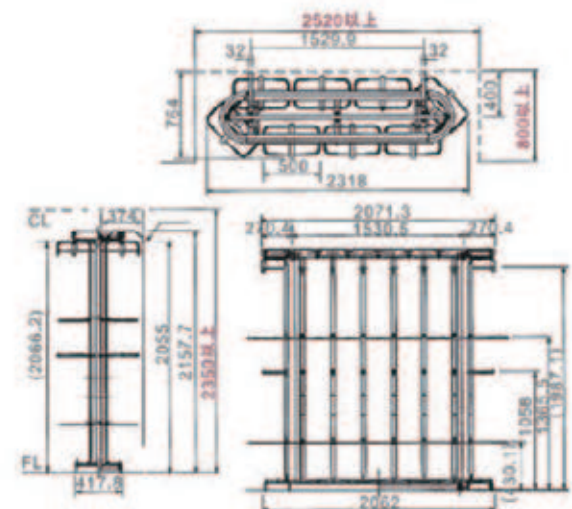



■ UNO 配件組合圖

立柱組裝方式：

一字型壁面立柱固定於牆面並與
立柱本體垂直相接，配件安裝於
立柱側身。

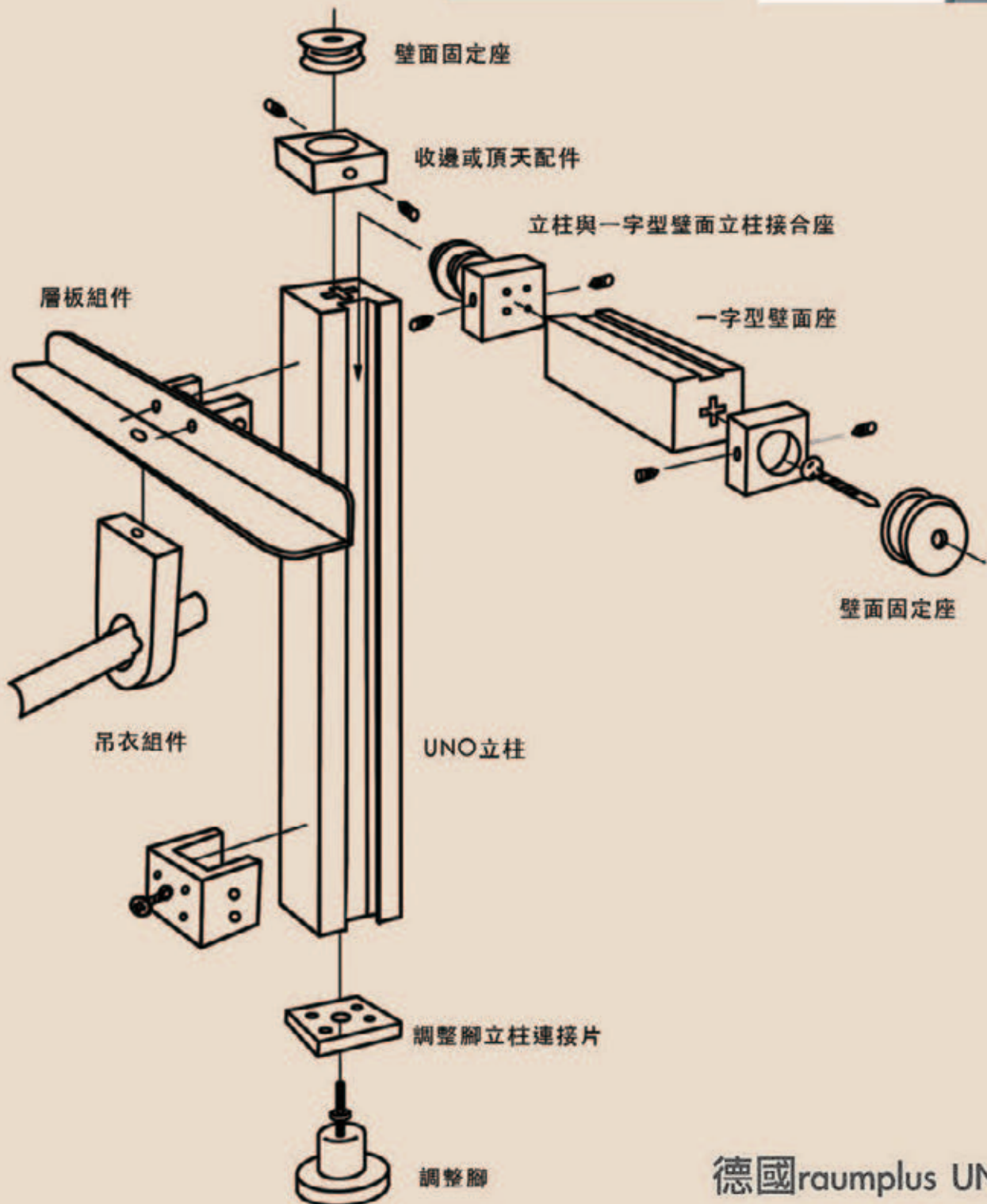

德國raumplus UNO



翼瓏阻尼衣物皮革藍

SOFT-CLOSE LEATHER BASKET

型號 Item No.	規格 (寬x深x高) Specification	適用櫃體 Cabinet width	價格 Price
6060280A	764x460x190mm	761-795mm	NT\$4000
6060290A	864x460x190mm	861-895mm	NT\$4000

■ 材質：鋁合金 ■ 售完為止



翼瓏阻尼西褲架

SOFT-CLOSE TROUSERS RACK

型號 Item No.	規格 (寬x深x高) Specification	適用櫃體 Cabinet width	價格 Price
6060480A	764x460x68mm	761-795mm	NT\$3750

■ 材質：鋁合金 ■ 售完為止



翼龍阻尼飾物架

SOFT-CLOSE DECORATION SHELF

型號 Item No.	規格 (寬x深x高) Specification	適用櫃體 Cabinet width	價格 Price
6060680A	764x460x68mm	761-795mm	NT\$4500
6060690A	864x460x68mm	861-895mm	NT\$4680

■ 材質：鋁合金 ■ 售完為止



翼瓏頂裝旋轉掛衣架

JADE TOP-INSTALL ROTATABLE HANGER

型號 Item No.	規格 (寬x深x高) Specification	適用櫃體 Cabinet width	價格 Price
6061700A	Φ520xH125mm	≥764mm	NT\$1600

■ 材質：鋁合金 ■ 售完為止





- 本公司保留一切產品之規格、功能、顏色、等之修改權
- 本型錄照片因印刷關係，顏色略有差異以實際產品為準
- 樣式與價格以實品為準



官方LINE



粉絲專頁

raumplus UNO

LAMP® Hettich

